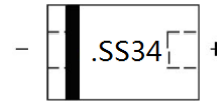

**SS34**
**3A, Schottky Barrier Diode**
[Http://:www.sh-willsemi.com](http://www.sh-willsemi.com)
**Features**

- Schottky barrier rectifier
- Guarding protection
- Low forward voltage
- Reverse energy tested
- High current capability
- Extremely low thermal resistance
- Standard products are Pb-free and Halogen-free

**SMA (DO-214AC)**

**. SS34= Device code**  
**Pin configuration and Marking**

**MECHANICAL DATA**

- Case: SMA molded plastic body
- Polarity: Color band denotes cathode end
- Mounting position: ANY

**Order information**

Device	Package	Shipping
SS34	SMA (DO-214AC)	5000/Tape&Reel

**Absolute maximum ratings**

Parameter	Symbol	Value	Unit
Maximum Repetitive Peak Reverse Voltage	$V_{RRM}$	40	V
Maximum RMS voltage	$V_{RWS}$	28	V
Maximum DC blocking voltage	$V_{DC}$	40	V
Maximum average forward rectified current at $T_L$ (Fig.2)	$I_{F(AV)}$	3.0	A
Peak forward surge current 8.3ms single half-sine-wave	$I_{FSM}$	50	A
Operating temperature range	$T_J$	-55 ~ 125	°C
Storage temperature range	$T_{STG}$	-55 ~ 150	°C

**Thermal Characteristics**

Parameter	Symbol	Value	Unit
Maximum thermal resistance (Junction to Lead)(Fig.2)	$R_{\theta JL}$	24	°C/W

**Electronics characteristics ( $T_A=25^\circ\text{C}$ )**

Parameter	Symbol	Value	Unit
Maximum instantaneous forward voltage @ $I_F=3.0\text{A}^*$	$V_F$	0.60	V
Maximum reverse current @ $V_{DC}$ ( $T_J=25^\circ\text{C}$ )	$I_R$	0.4	mA
Maximum reverse current @ $V_{DC}$ ( $T_J=100^\circ\text{C}$ )	$I_R$	10	mA

\*: Pulse test, Pulse width 380us, duty cycle 1%

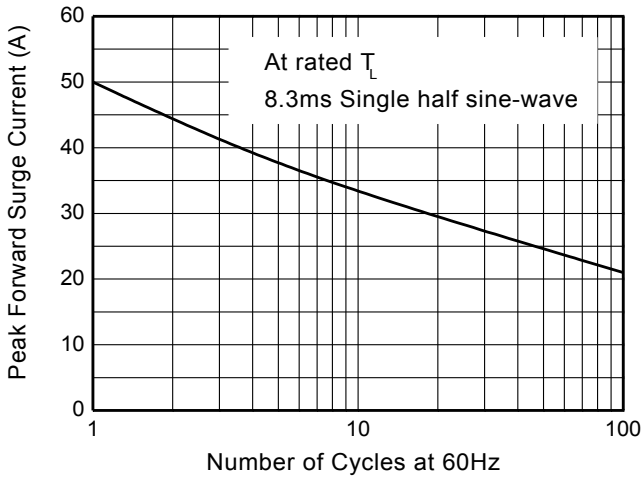
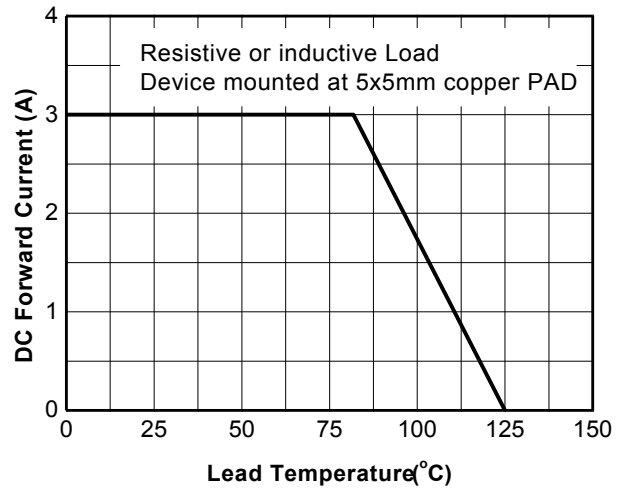
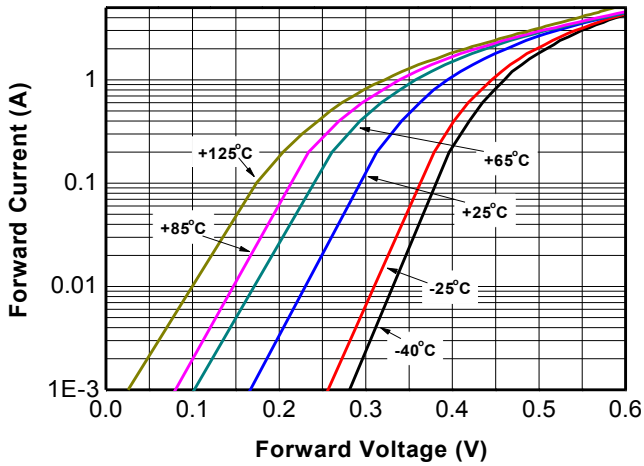
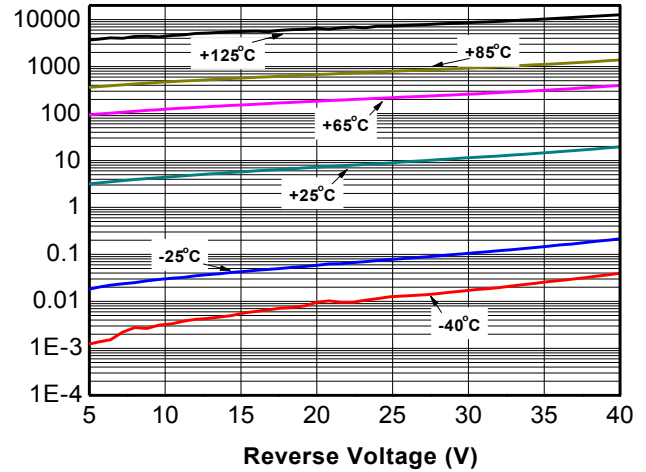
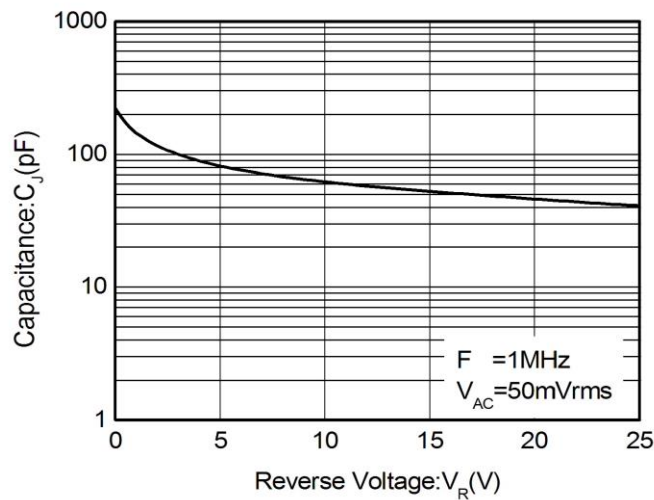
**Typical characteristics (Ta=25°C, unless otherwise noted)**

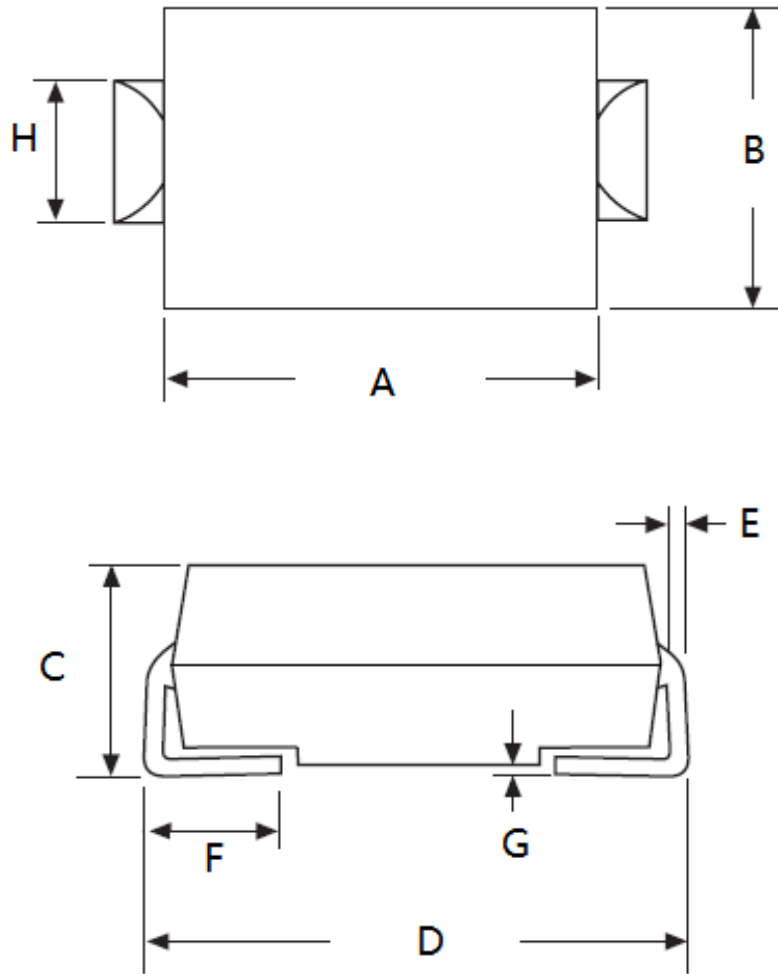
**Fig.1: Peak Forward Surge Current**

**Fig.2: Forward current Derating Curve**

**Fig.3: Typical Forward Characteristics**

**Fig.4: Typical Reverse Characteristics**

**Fig.5: Junction capacitance vs. Reverse voltage**

**Package outline dimensions**
**SMA (DO-214AC)**

Symbol	Dimensions in millimeter	
	Min.	Max.
A	3.90	4.40
B	2.45	2.75
C	1.90	2.40
D	4.85	5.25
E	0.152	0.305
F	0.76	1.52
G	0.203 Max.	
H	1.45	1.95